

For the Following Apartments (Type A1)

One Bedroom Apartment

115, 205, 217,
305, 317, 405, 417

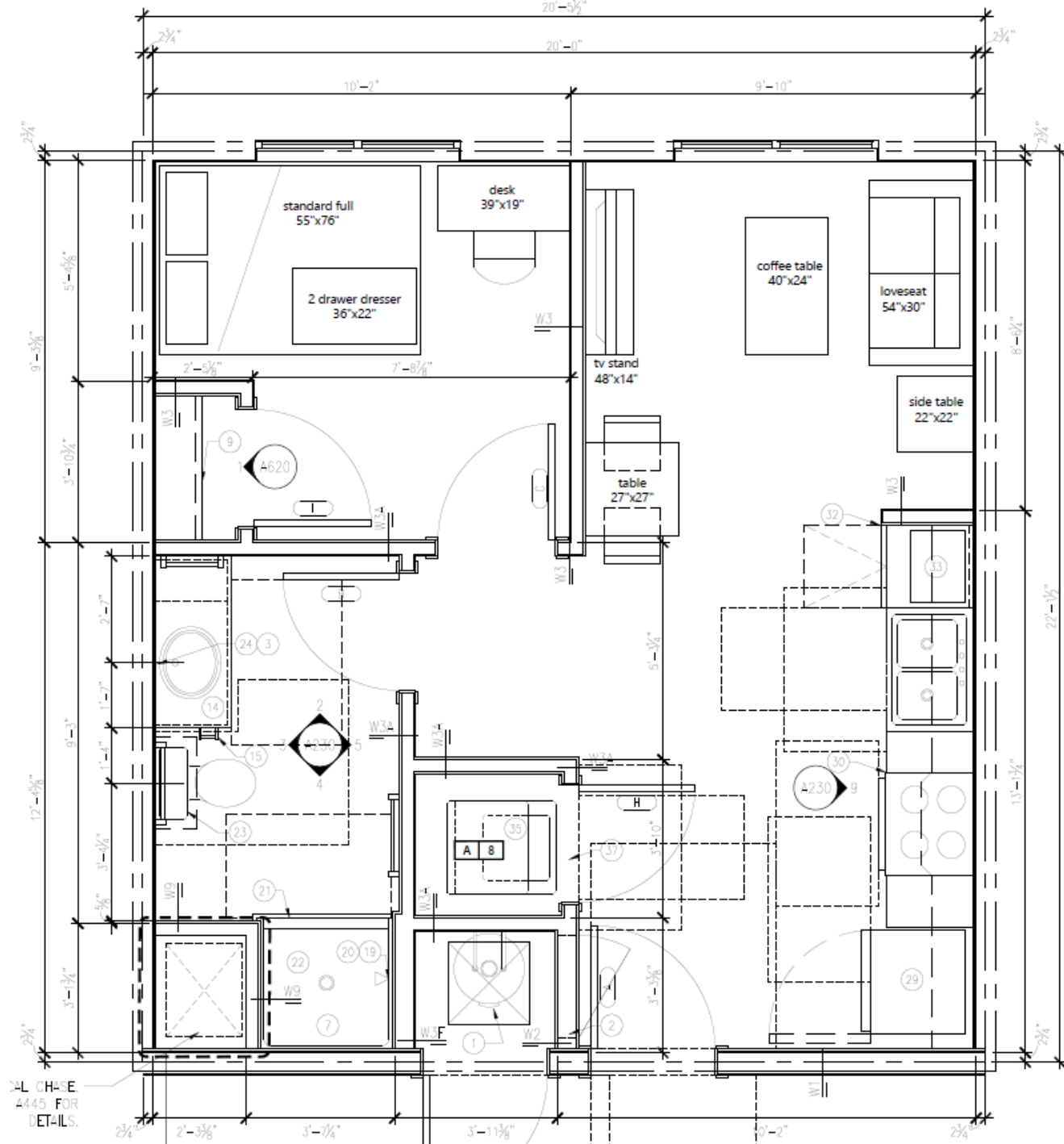
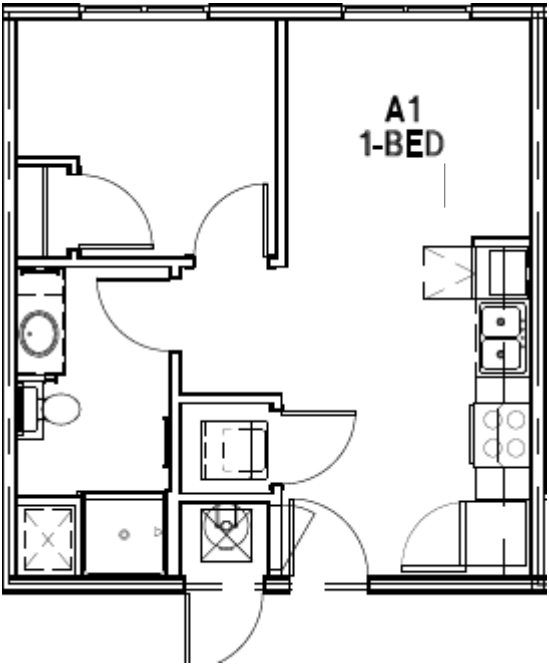

For the Following Apartments (Type A2)

One Bedroom Apartment

207, 307, 407

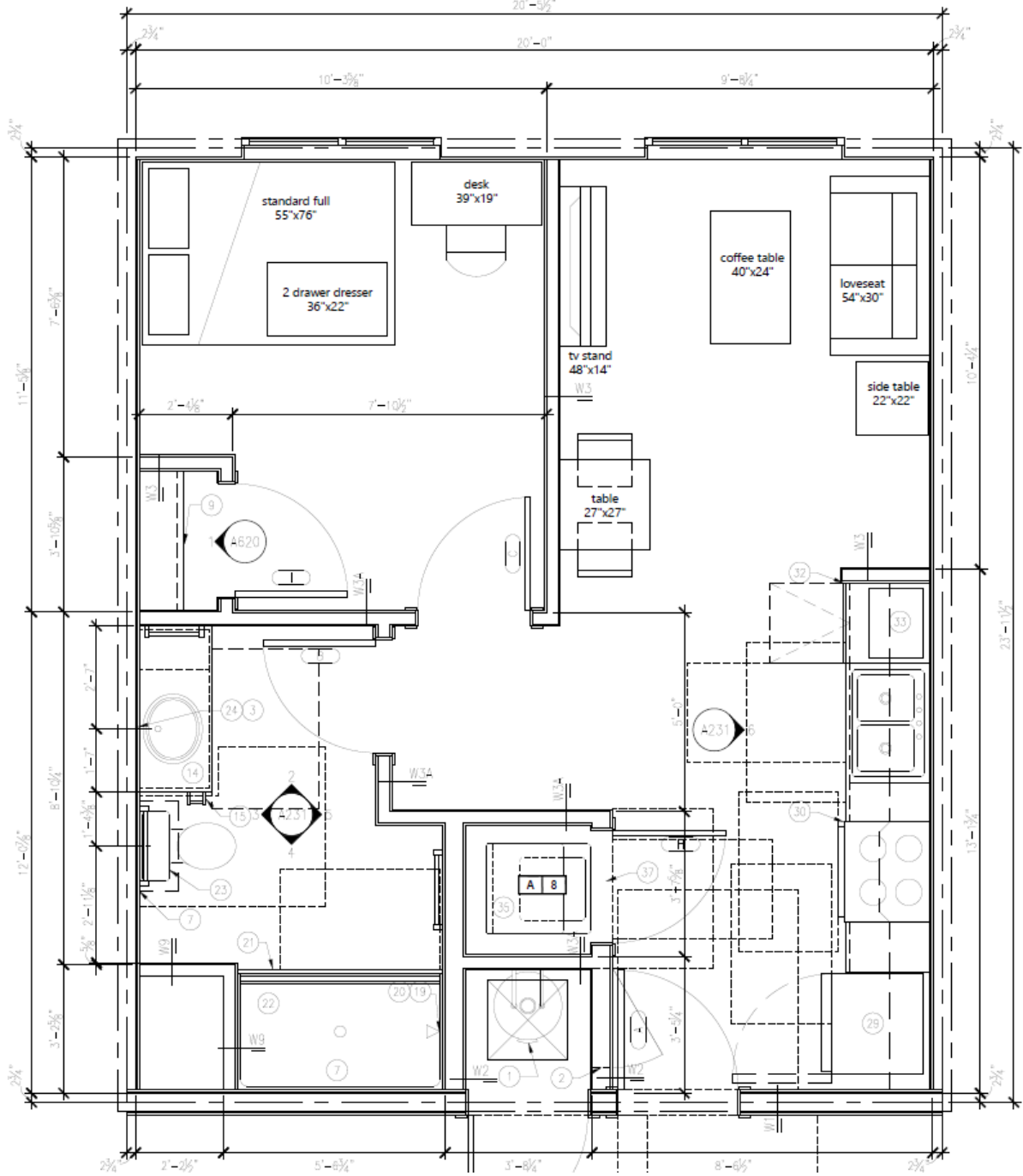
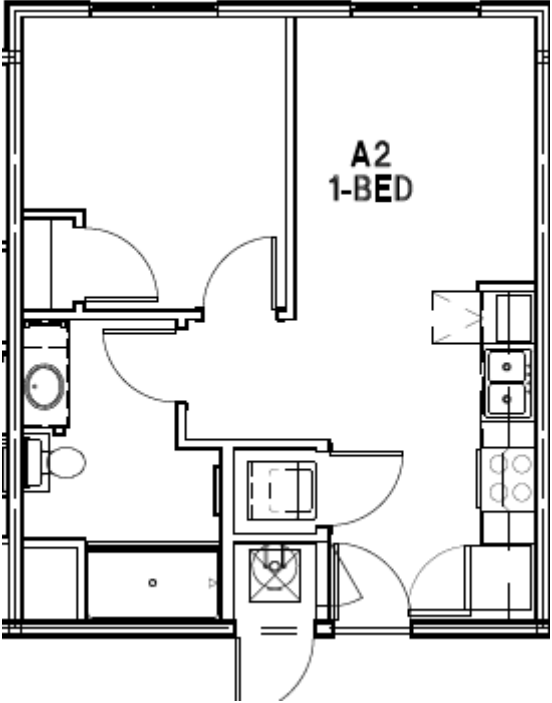

For the Following Apartments

One Bedroom Apartment

Type A1:

115, 205, 217, 305, 317, 405, 417

Type A2:

207, 307, 407

Apartments may vary in dimensions

Kitchen View

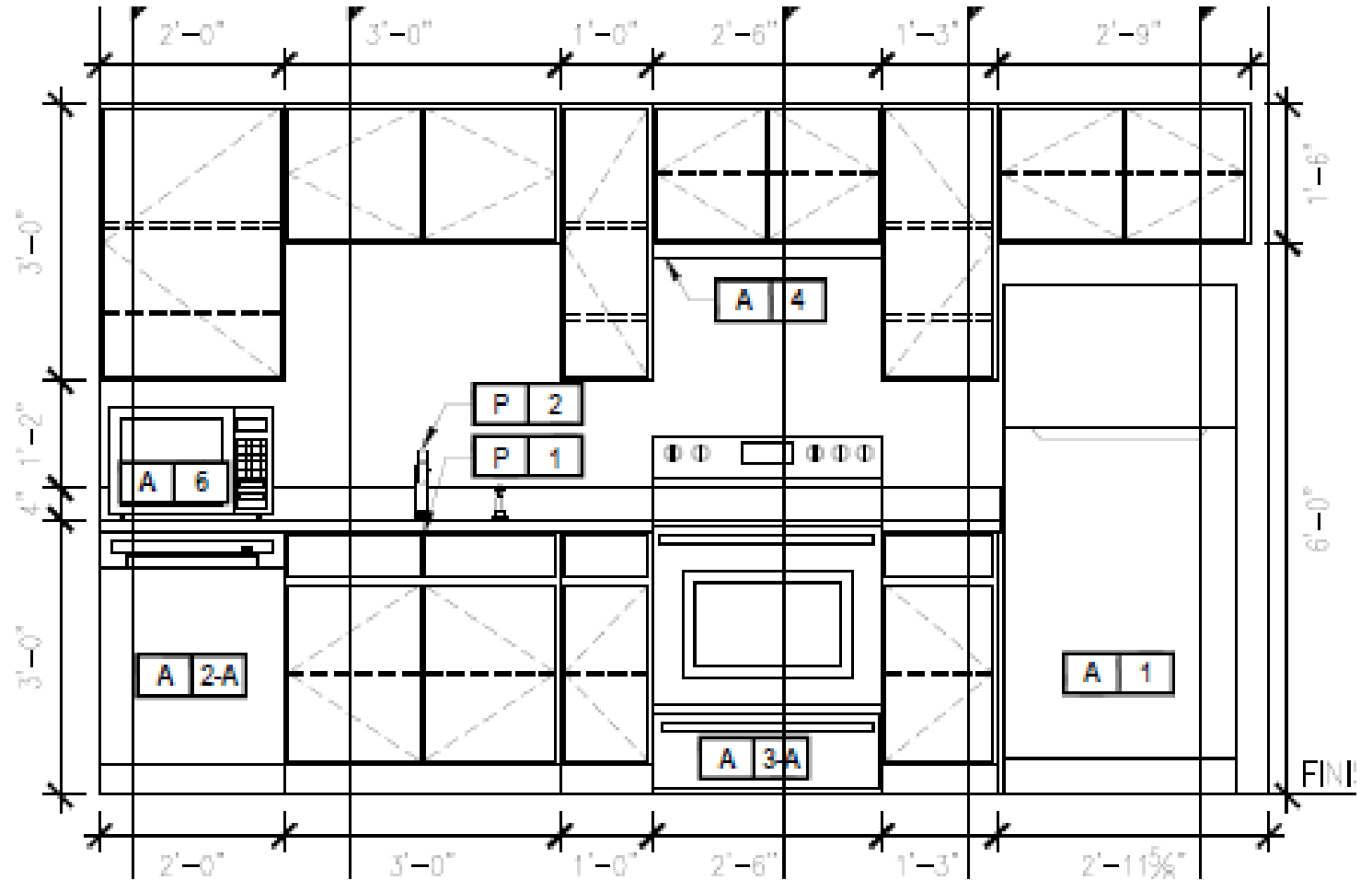

For the Following
 Apartment (Type A2)
 One Bedroom Apartment
 105 - Fully Accessible)

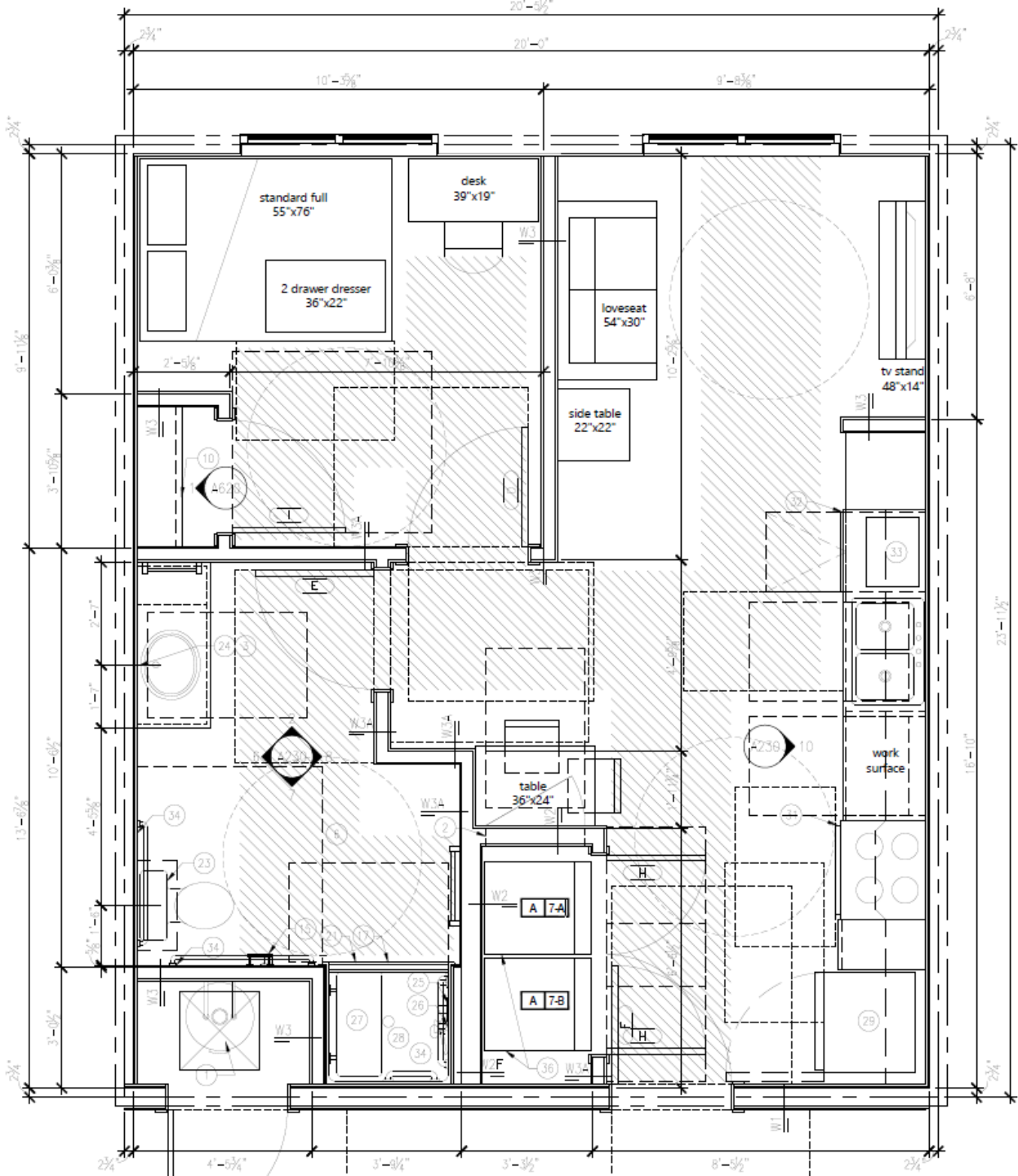
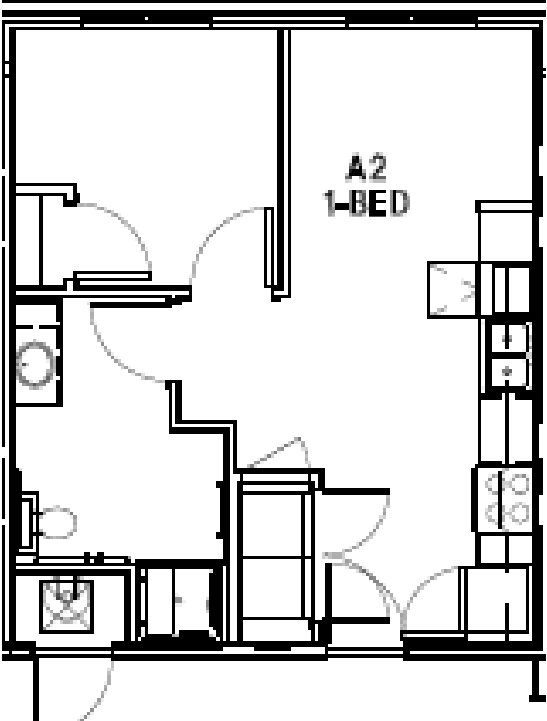

For the Following Apartments (Type A2)

One Bedroom Apartment

207, 307, 407

Apartments may vary
in dimensions

Kitchen View

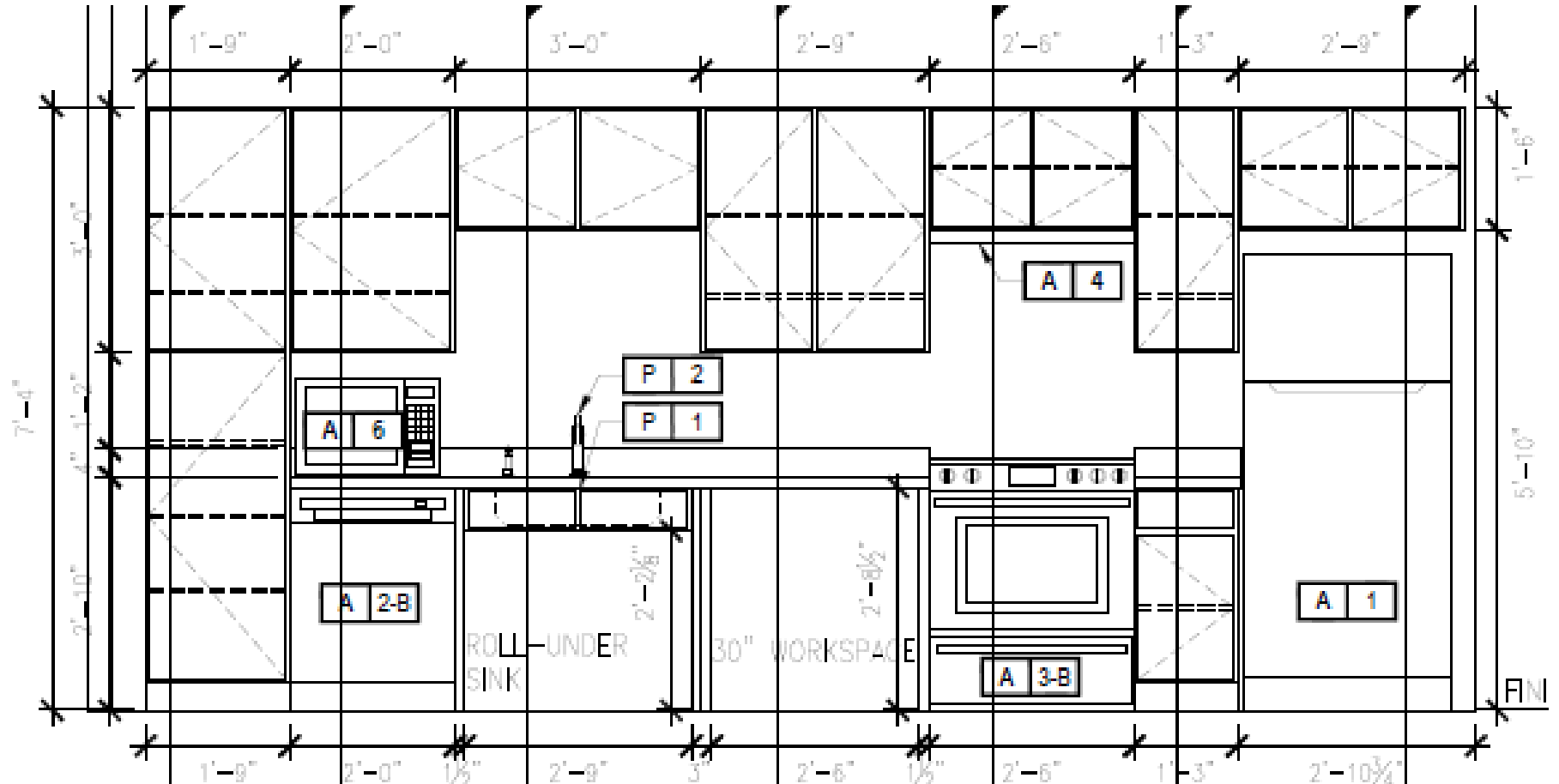

For the Following Apartments (Type B2)

Two Bedroom Apartment

212, 312, 412

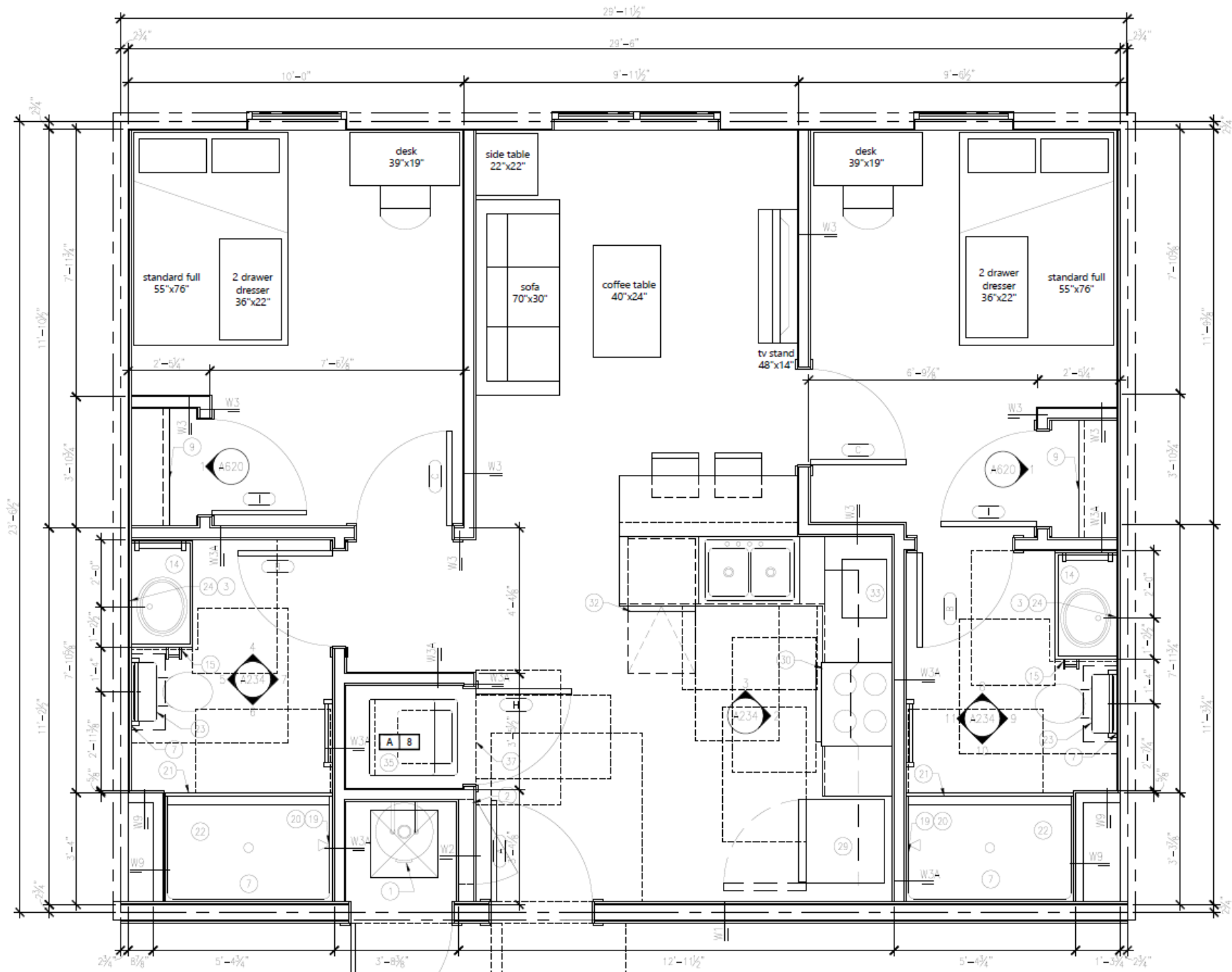
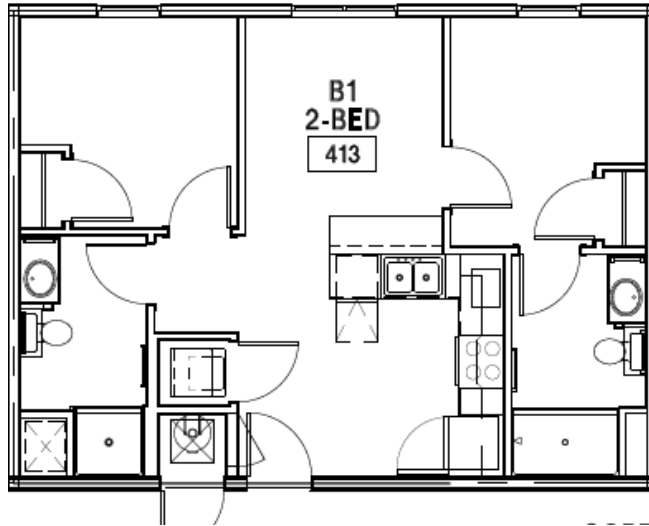

For the Following Apartments (Type B1 & B2))

Two Bedroom Apartments

B1 107, 109, 111, 113
209, 211, 213, 214

309, 311, 313, 315
409, 411, 413, 415

B2 212, 312, 412

Apartments may vary
in dimensions

Kitchen View

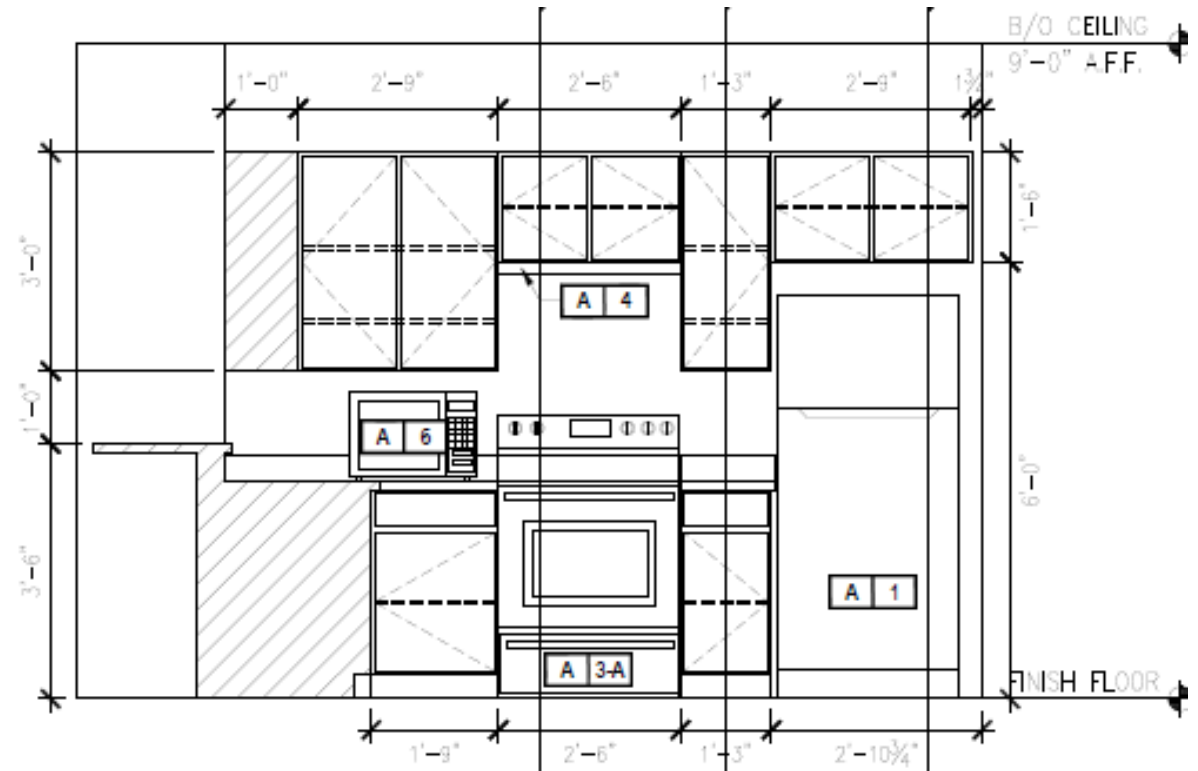
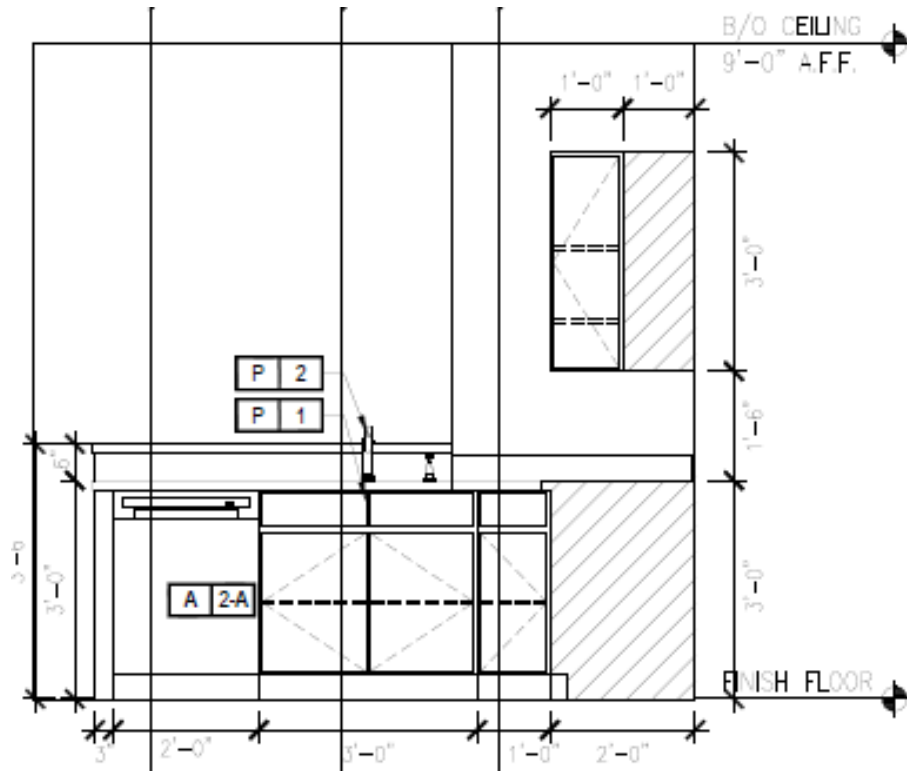

For the Following Apartment (Type B2) Two Bedroom Apartment

112 - Fully Assessable

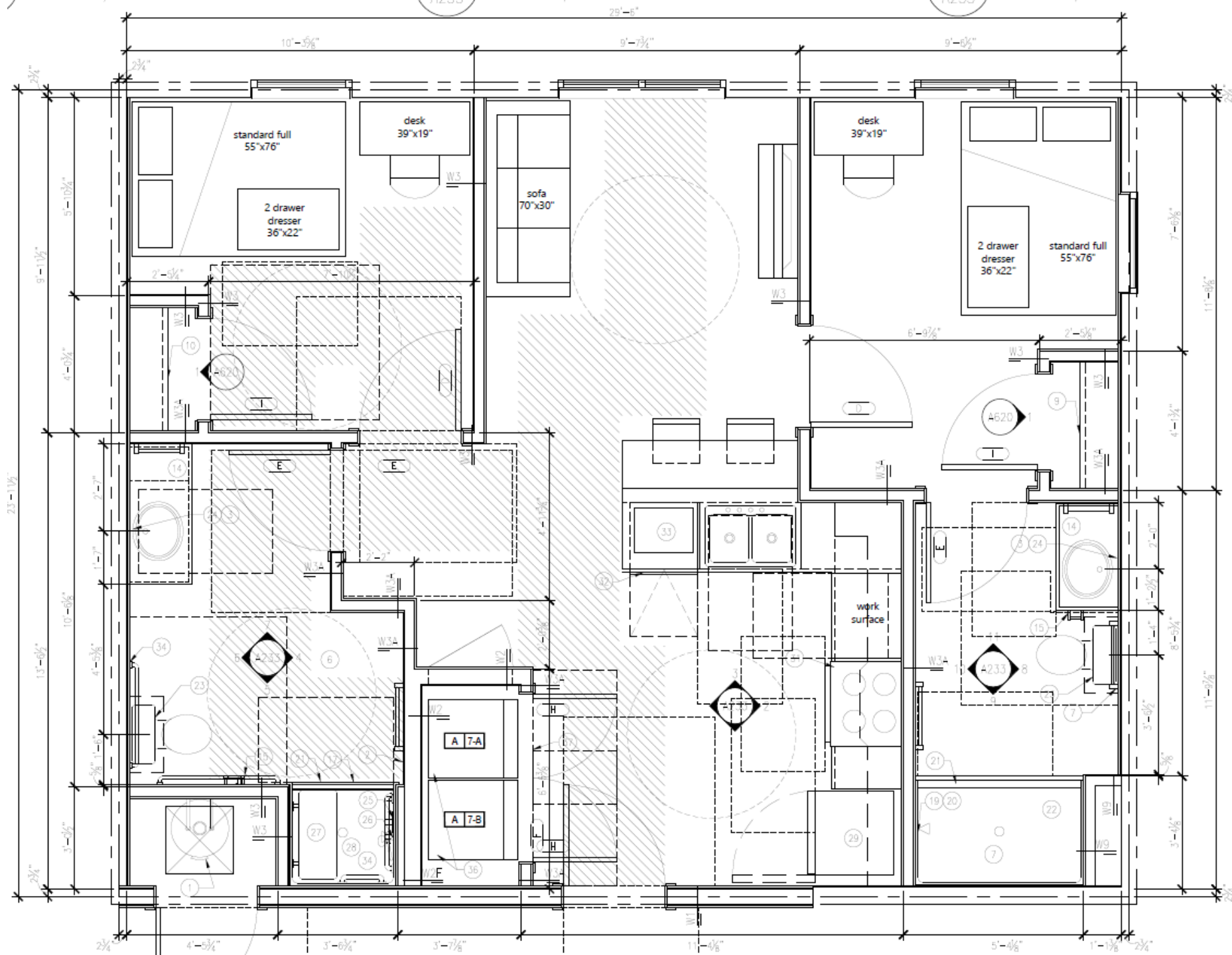
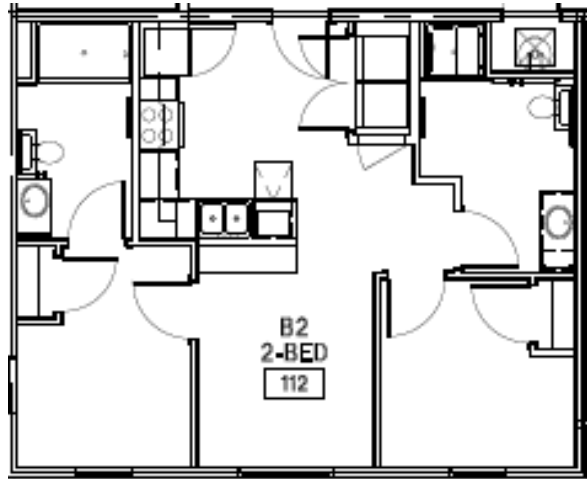

For the Following
Apartment (Type B2)

Two Bedroom Apartment

112 - Fully Assessable

Kitchen View

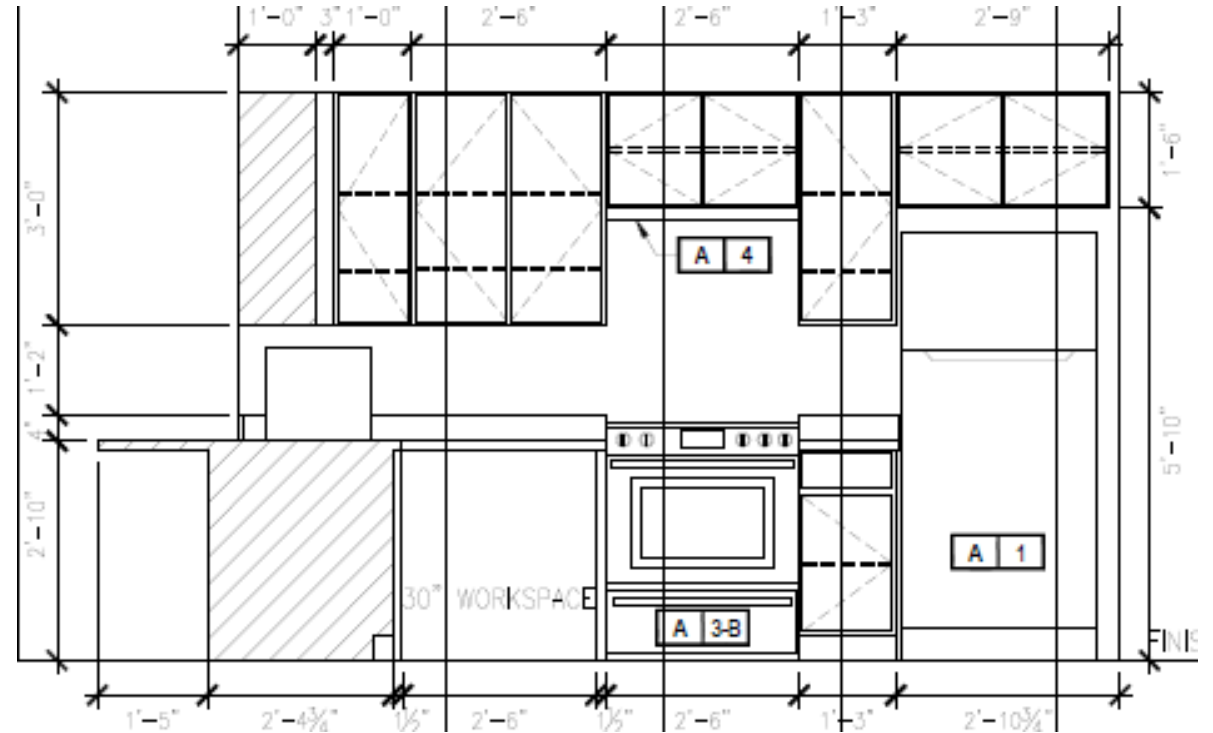
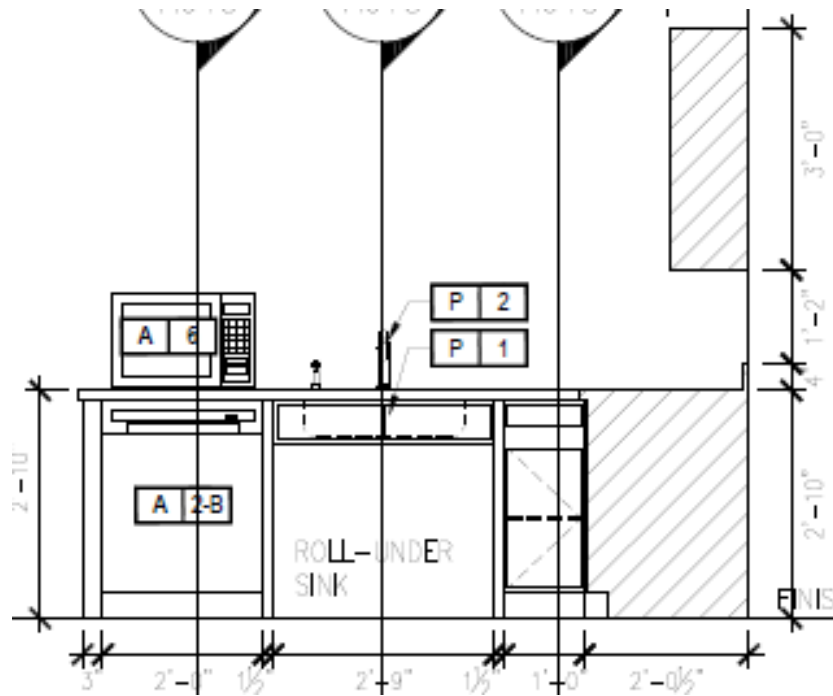

For the Following
Apartments (Type B4)
Two Bedroom Apartment

202, 203

302, 303

402, 403

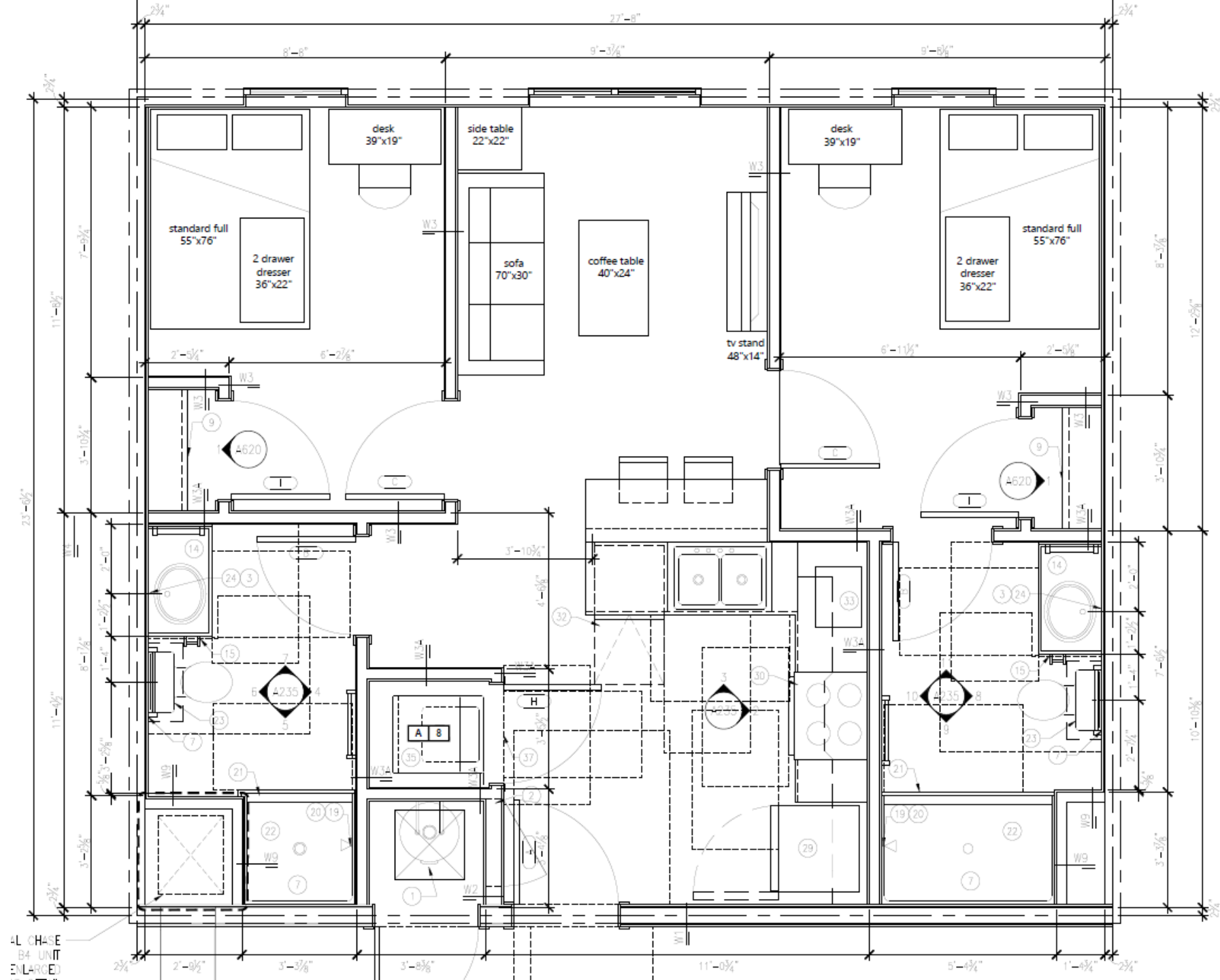
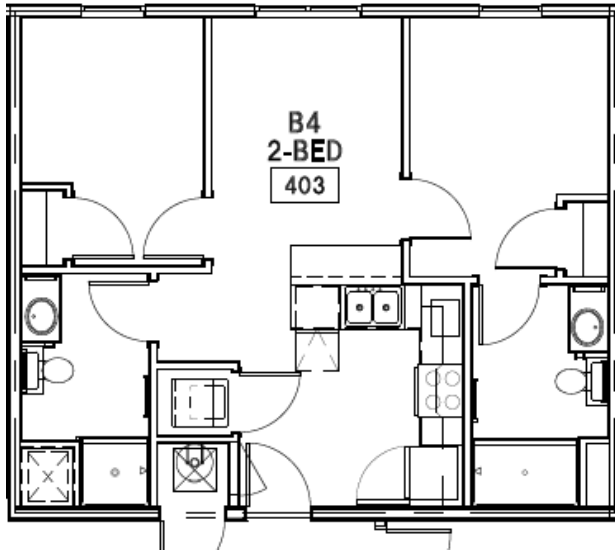

4L CHASE
B4 UNIT
ENLARGE

For the Following
Apartments (Type B4)

Two Bedroom Apartment

202, 203

302, 303

402, 403

Kitchen View

Apartments may vary
in dimensions

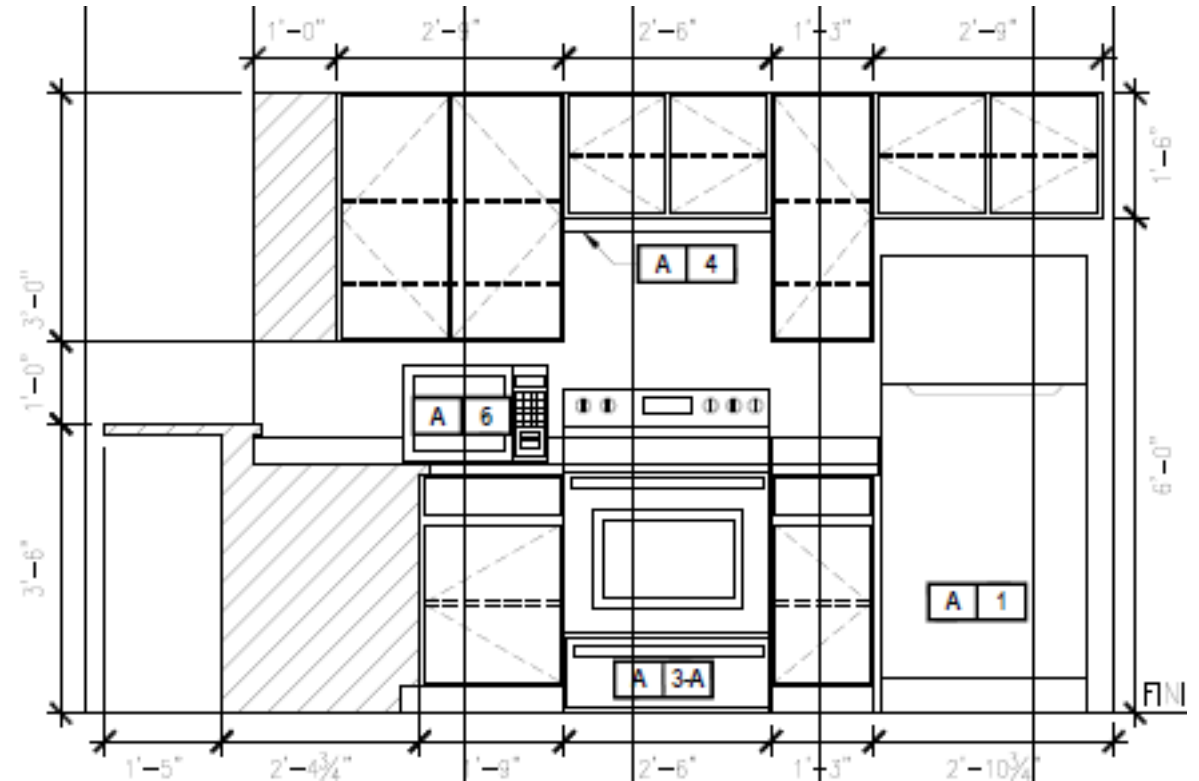
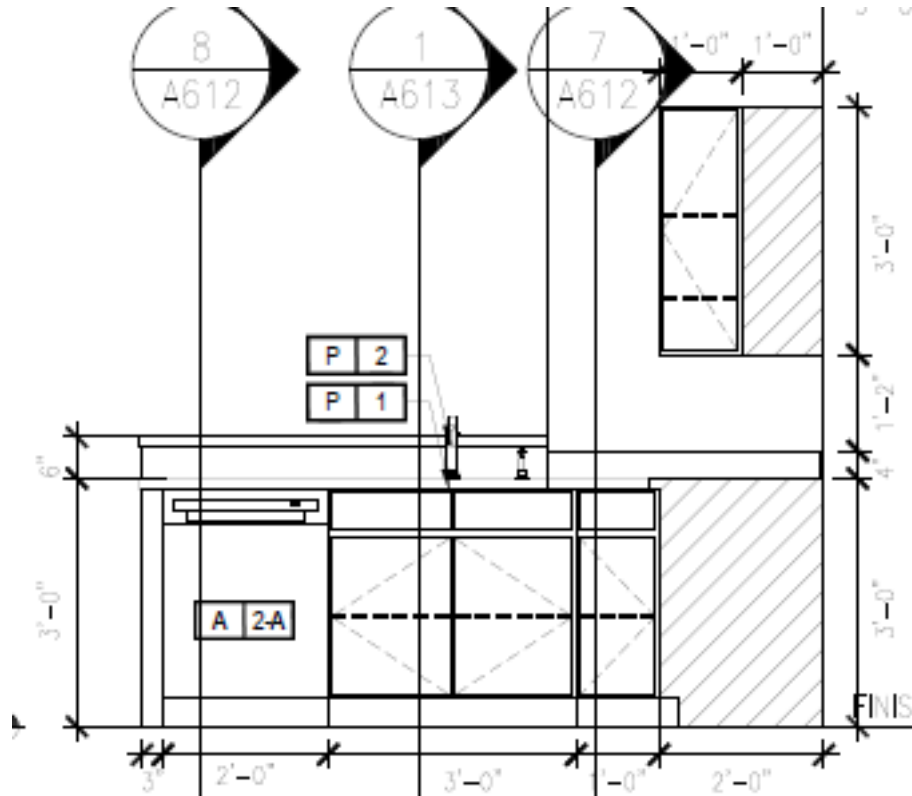

For the Following Apartments (Type B5)
Two Bedroom Apartment

200, 201
300, 301
400, 401

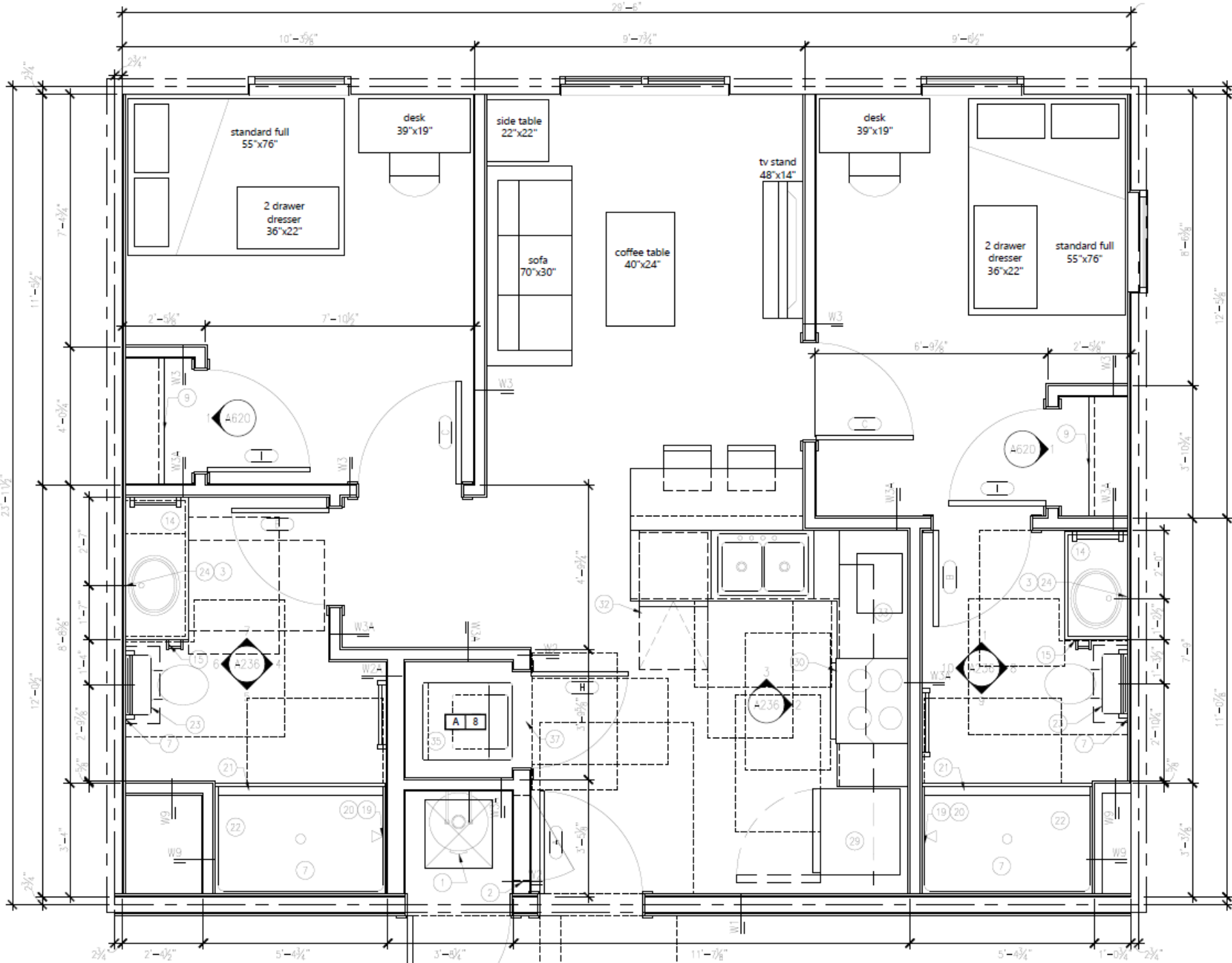
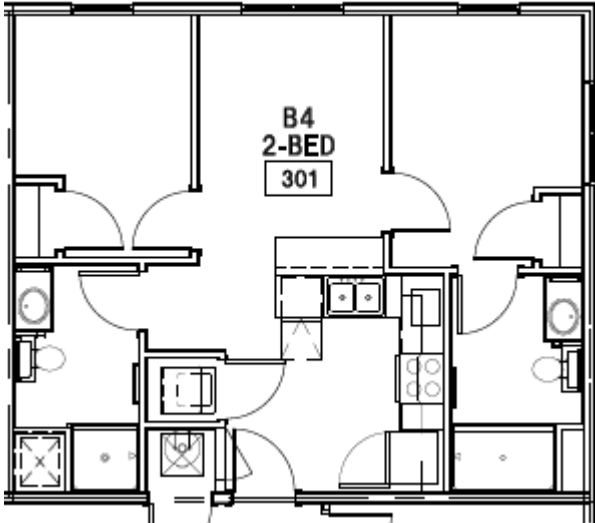

For the Following
Apartments (Type B5)

Two Bedroom Apartment

200, 201

300, 301

400, 401

Kitchen View

Apartments may vary
in dimensions

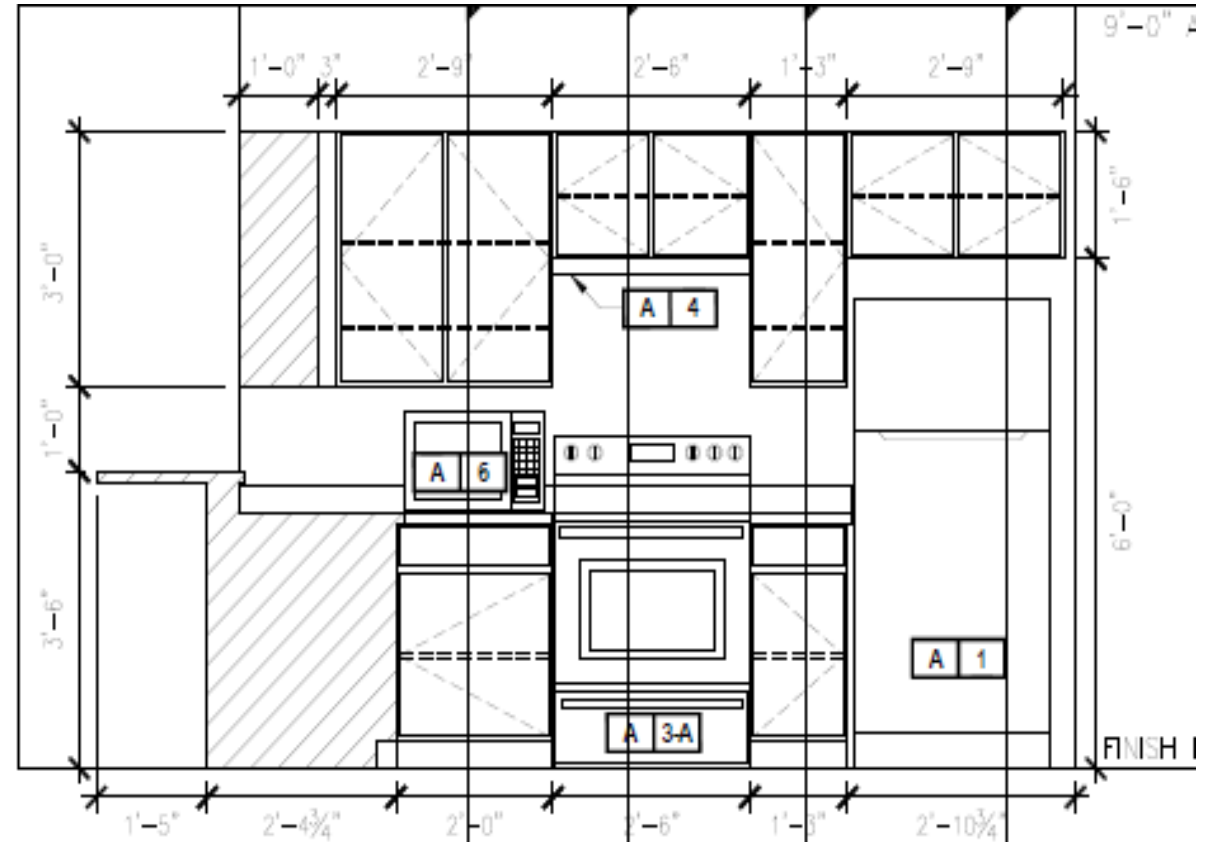
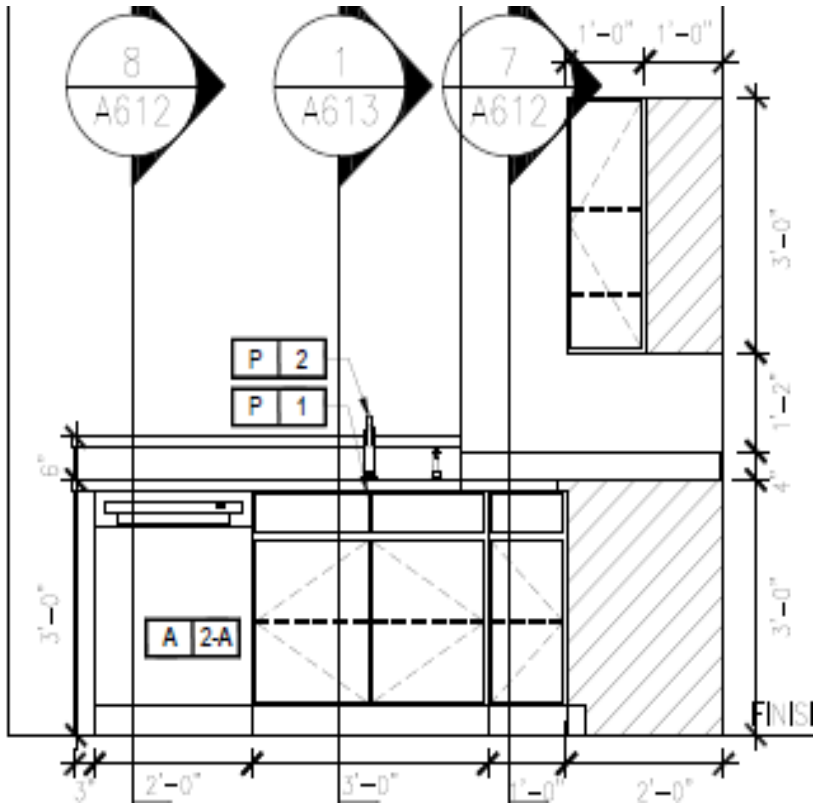

For the Following Apartments (Type D1)

Four Bedroom Apartment 108, 110, 206, 208, 210, 306, 308, 310, 406, 408, 410

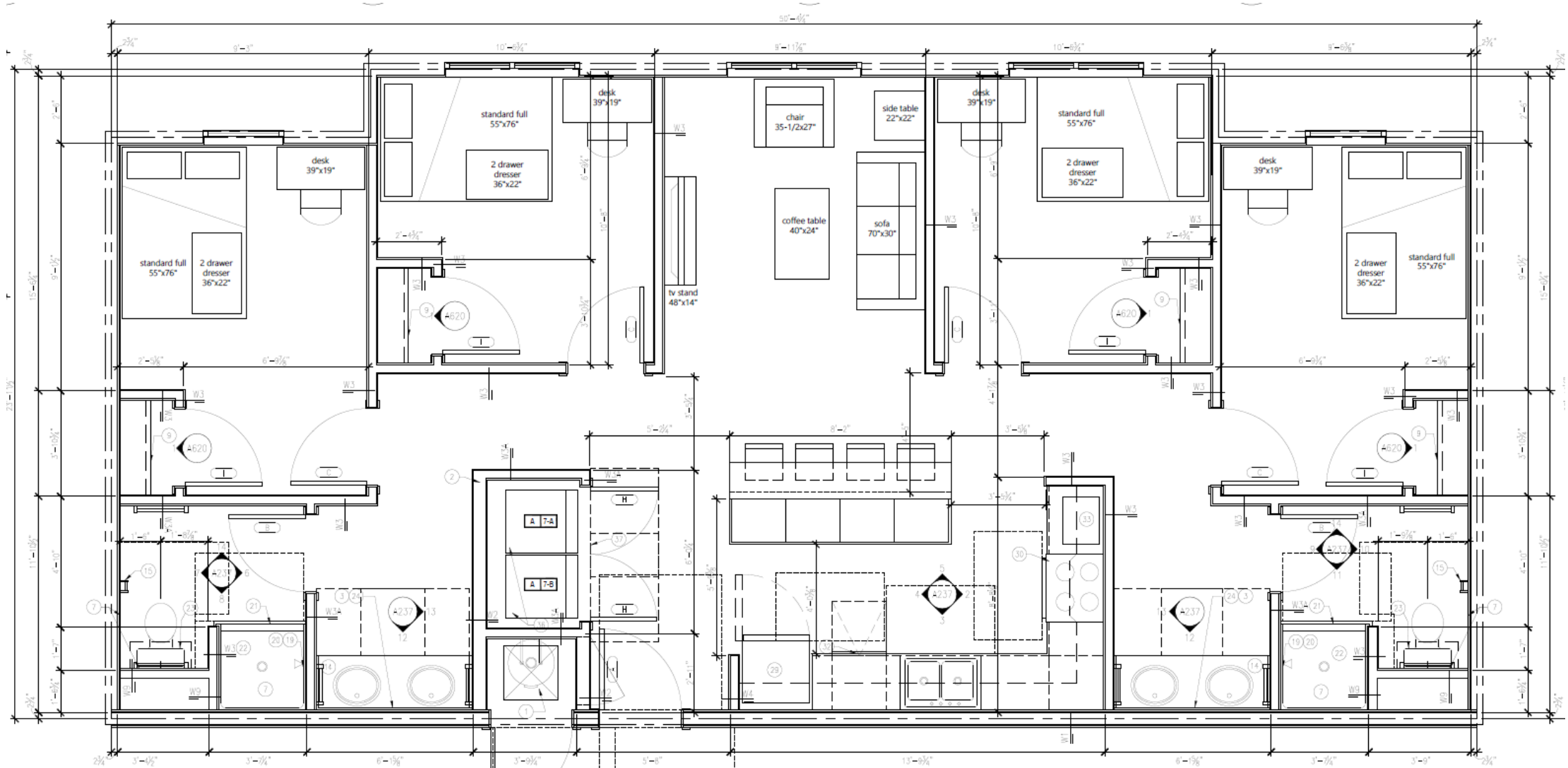
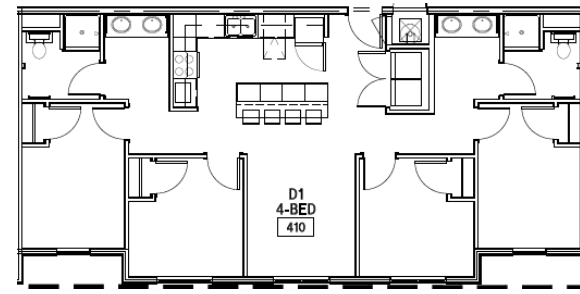

Kitchen View

For the Following Apartments (Type D1)

Four Bedroom Apartment

108, 110, 306, 308, 310

206, 208, 210 406, 408, 410

Apartments may vary
in dimensions

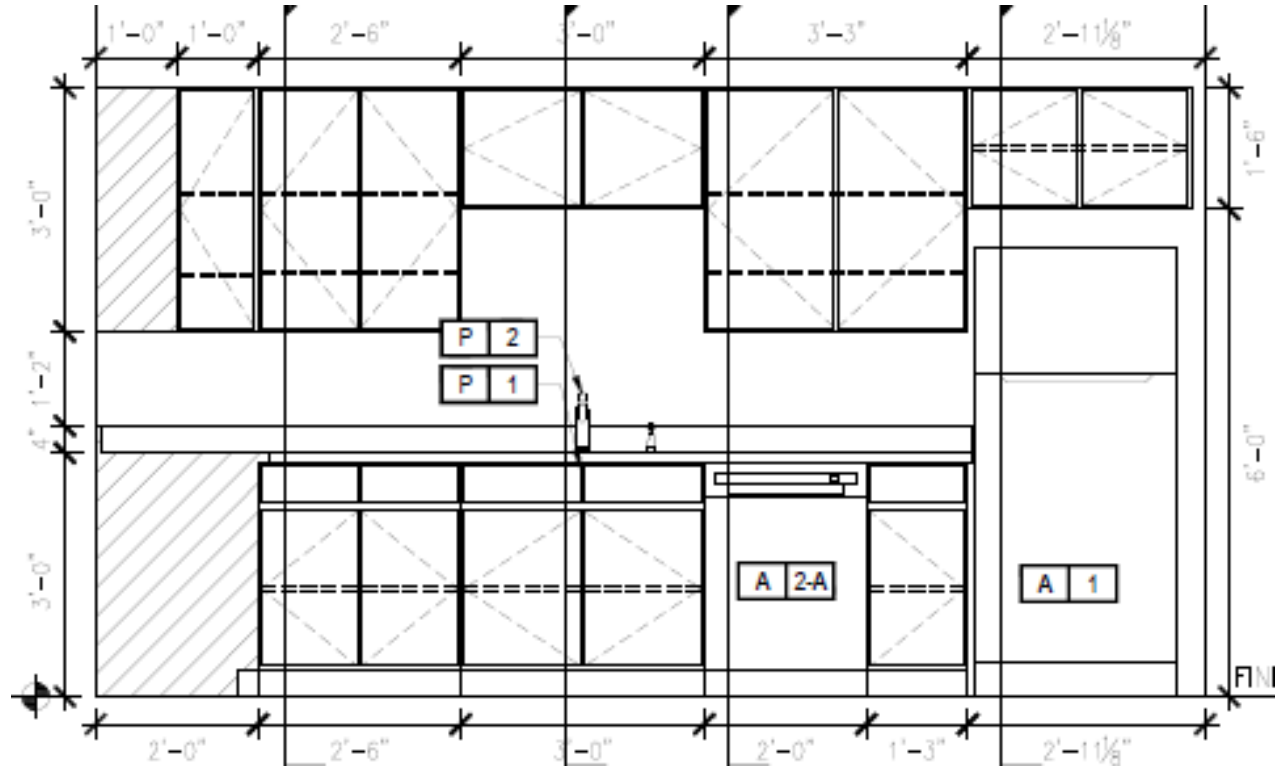
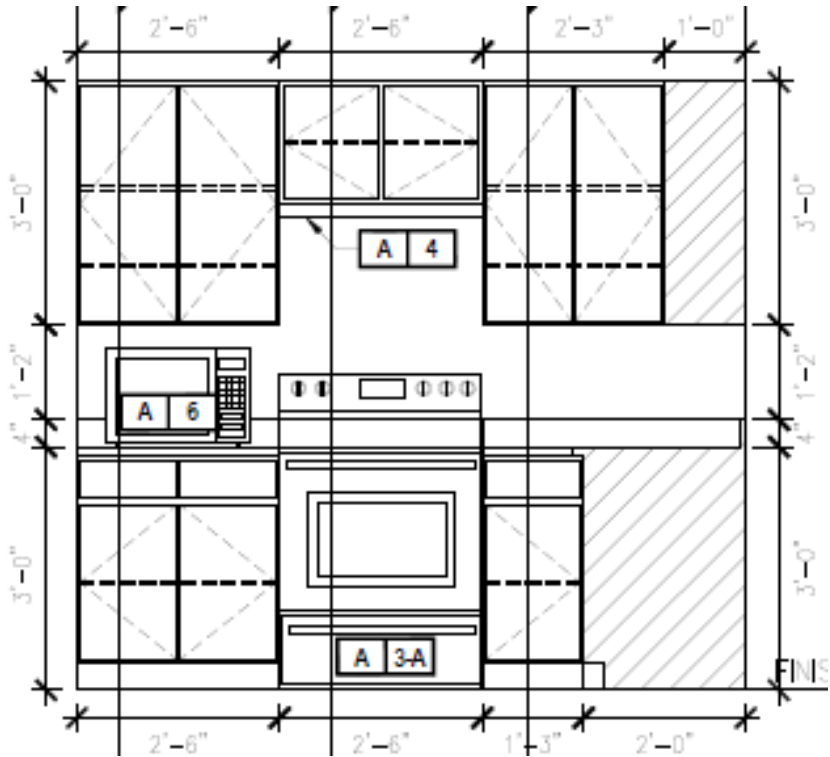

For the Following Apartments (Type D2)

Four Bedroom Apartment 106 – Assessable

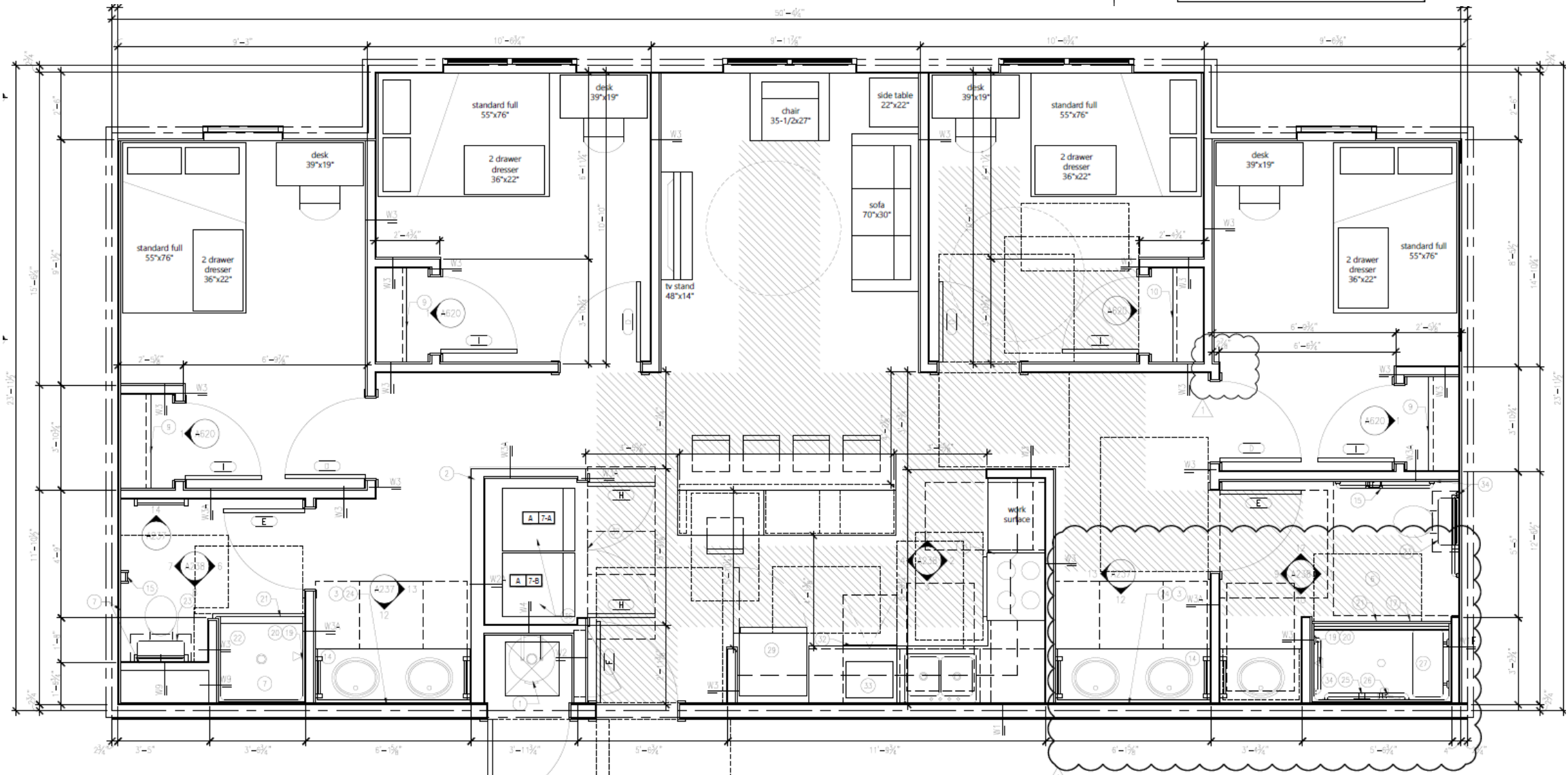
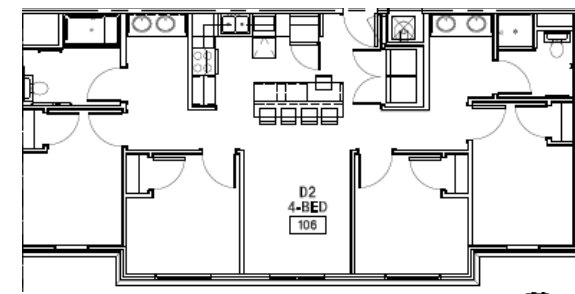

For the Following Apartment (Type D2)
Four Bedroom Apartment 106 – Assessable

Kitchen View

Apartments may vary
in dimensions

